

Data Sheet



Article number: 432000360

Description: Rota-fix shaft-hub connection A 360x455
Steel

Note: Not self centering. Medium-high torques.

Measures

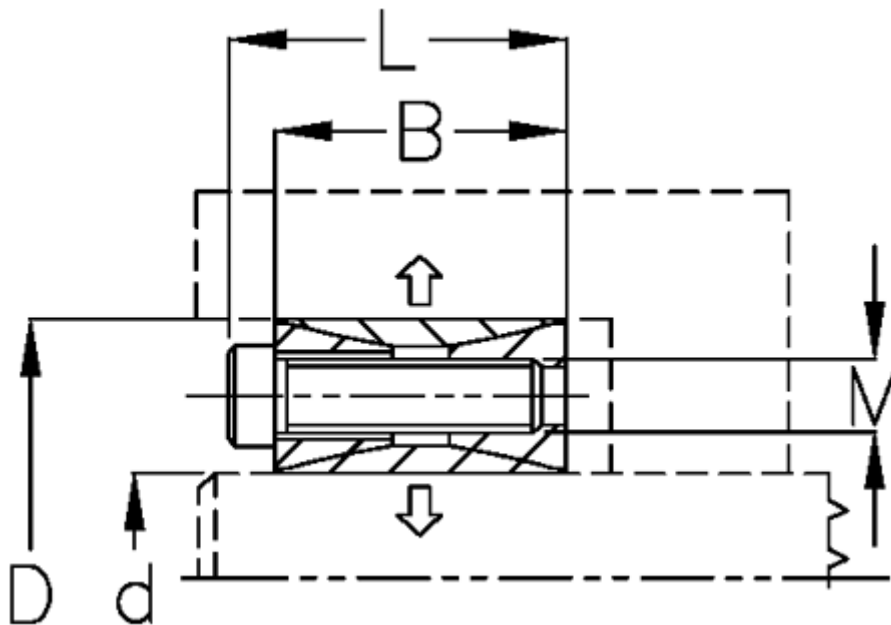

B mm	= 90
d H8 mm	= 360455
D mm	= 455
Fit tolerance	= Aksel k11-h11, Nav N11-H11
F kN torque	= 1844.0
L mm	= 112
M mm	= M22
P N/mm ² surface pressure on shaft/hub	= 128

Surface roughness	=
T N m torque	=
Ts N m bolt tightening torque	=